

MOBILE-/FIXED CONTACT SYSTEM K08 . . . ■■■

PART - N°.: 045678 / 045702

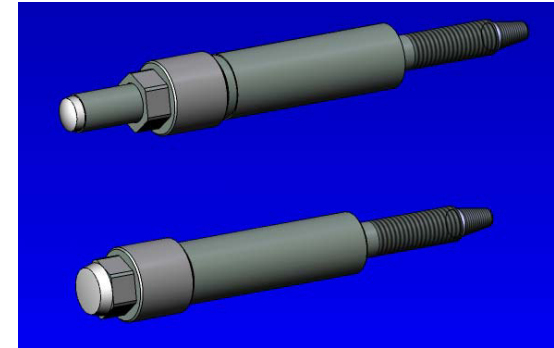
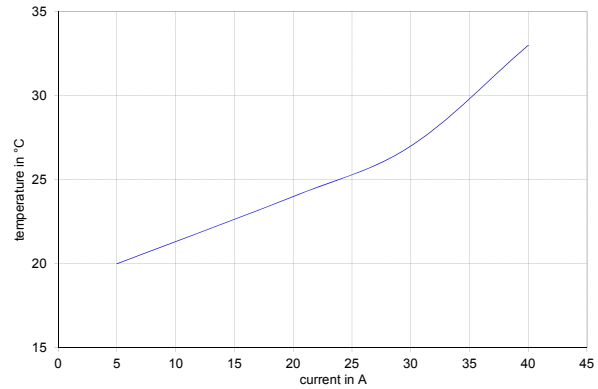
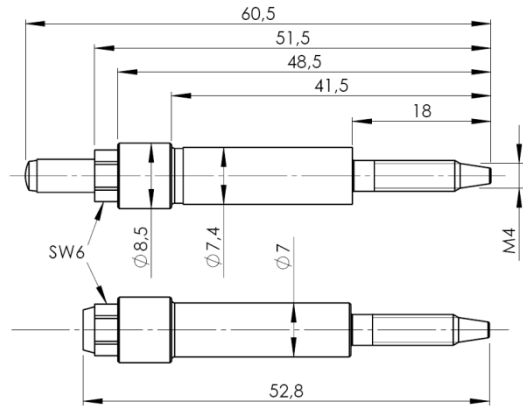

Mechanical data:

Max. tightening moment:	2 Nm
Force at 6 mm stroke:	12 N
Max. stroke:	8 mm
Max. compression cycles:	100 000
Material:	brass
Surface:	silver plated
Weight:	approx 28 g

Electrical data:

Permanent load:	30 A
Pulse load:	1 kA
Contact resistance:	< 1 mΩ
Conduction range:	0 - 30 MHz
Attenuation (at 30 MHz):	< 0,1 dB
Max. temperature:	80 °C *



*) Temperature progression at 25 °C environmental temperature, lead connected with 6 mm² wire gauge. Different temperature progressions will result from different wire gauges applied, to DIN VDE 0298. To consider: The values only obtain in combination with era-contact contact studs and zero potential connecting. The permanent load decreases if only the thread is being used to transmit power. The specified values correspond to our actual knowledge. The tests which underlie this data sheet correspond to the present standards and actual knowledge. The values are issued without any responsibility for any unjustified application of the product. This document does not release the customer from carrying out a vendor inspection control. Users of era-contact products should make their own evaluation to determine the suitability of each such product for the specific application. We advise that the era-contact contact system shall under no circumstances be combined with inappropriate third party products. The combination of the era-contact contact system with an inappropriate third party product may lead to serious or even deadly injuries. The combination of the era-contact contact system with any third party product has to be checked thoroughly and should not be performed without prior approval of era-contact. Any harm that is caused by the combination of the era-contact contact system with an inappropriate third party product is excluded from product liability.

era-contact GmbH, Gewerbestrasse 44, D-75015 Bretten, Tel.: +49-(0)7252-971-0, Fax.: +49-(0)7252-971-200, www.era-contact.de, e-mail: contact@era-contact.de

© era-contact GmbH Bretten 03/2017 V07 all rights and technical details subject to change!